

KMT2 Series

Ultra Miniature Tactile Switch 3.0 x 2.6mm,
with 0.65mm Height Actuator



Specifications

Function	Momentary action
Contact Arrangement	1 make contact = SPST, N.O.
Terminals	Gullwing type for SMT
Packaging	In reels of 4,000 pieces. Dimensions of reels according to EIA 481B External diameter 180 mm

Electrical Characteristics

Silver	
Maximum Power	0.5 VA
Maximum Voltage	32 VDC
Minimum Voltage	20 mV
Maximum Current DC	50 mA
Minimum Current DC	1 mA
Dielectric Strength	≥ 250 Vrms (1mn)
Contact Resistance	≤ 150mΩ
Insulation Resistance	≥ 50MΩ
Bounce Time	≤ 6 ms

Environmental Characteristics

Operating Temperature	-40°C to 85°C
Storage Temperature	-55°C to 85°C

Process

Soldering	This component is suited to the following methods: Lead free reflow soldering process in accordance with IEC 61760-1.
------------------	--

Note: Specifications listed above are for switches with standard options. For information on specific and custom switches, consult Customer Service Center.

Description

The KMT2 series nano-miniature SMT top actuated switch has the smallest footprint and thickness with an integrated actuator. Its high number of cycles within the smallest packaging makes it an ideal choice for designers working with limited space in applications such as hearing aids, Bluetooth headsets and MP3 accessories.

Features & Benefits

- Smallest footprint
- High number of cycles within the smallest packaging
- Smallest thickness with integrated actuator
- Ground pin option
- Halogen free

Applications

- Mobile Phones
- Hearing Aids
- MP3 accessories
- Bluetooth Headset

Dimensions (mm)

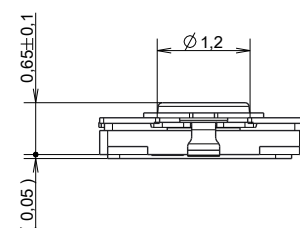
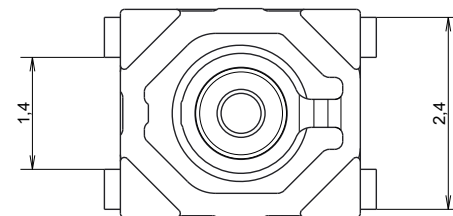
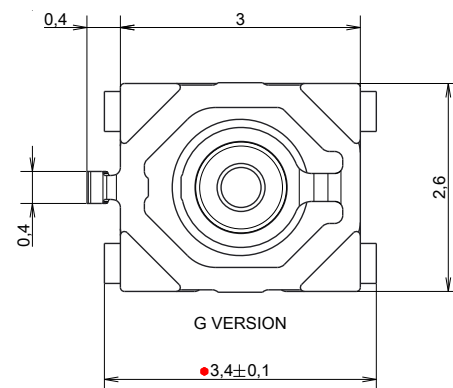

KMT2 Series

Ultra Miniature Tactile Switch 3.0 x 2.6mm,
with 0.65mm Height Actuator



Mechanical Characteristics

Type G and NG	Operating force Newtons (grams)	Operating Life	Tactile Feeling	Travel mm
KMT 211 HF LFS	1.0 (100) ± 0.25	150,000	≥ 10%	1.5 ± 0.1
KMT 221 HF LFS	1.6 (160) ± 0.40	150,000	≥ 30%	1.5 ± 0.1

KMT Series – No Ground Pin

Electrical Diagram

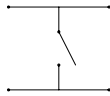

Recommended Layout

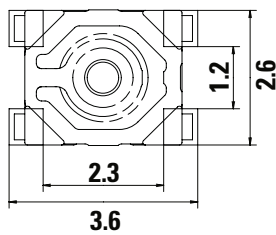

KMT Series – With Ground Pin

Electrical Diagram

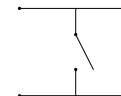

Recommended Layout

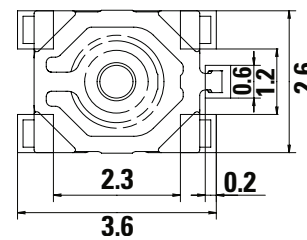

Tape & Reel

Section A-A

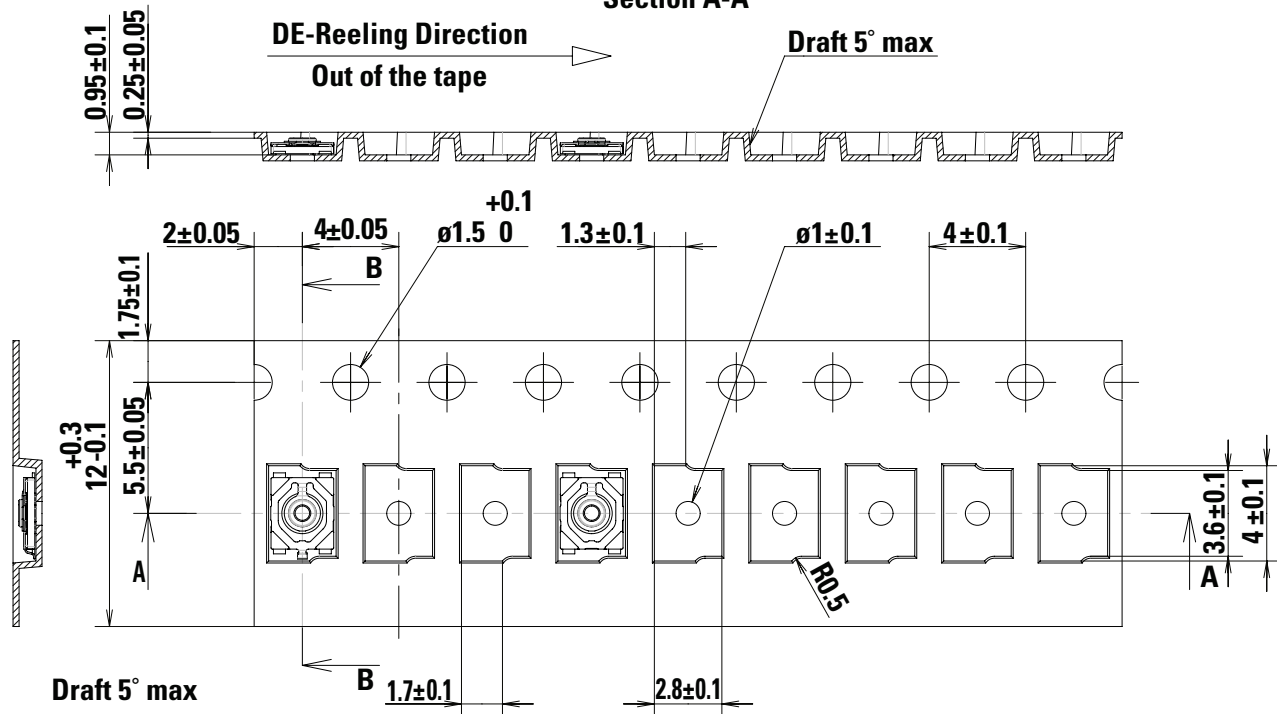

KMT2 Series

Ultra Miniature Tactile Switch 3.0 x 2.6mm,
with 0.65mm Height Actuator



Ordering Number

Our easy build-a-switch concept allows you to mix and match options to create the switch you need. To order, select desired option from each category. However, please note that not all combinations of these options are feasible. For any part number different from those listed below, please consult your local representative.

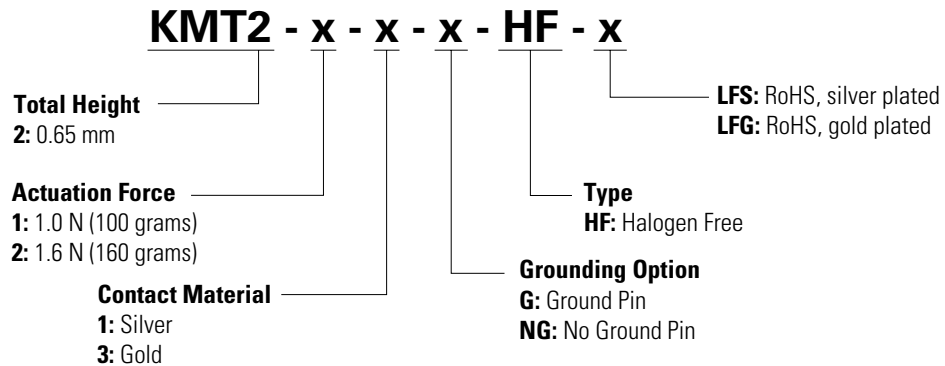

Liability Limitation

This datasheet does not provide enough information for applications that require a certain level of quality or safety such as automotive, medical systems, or safety equipment. Please contact customer service for the contractual specification package.

Disclaimer Notice - Information furnished is believed to be accurate and reliable. However, users should independently evaluate the suitability of and test each product selected for their own applications. Littelfuse products are not designed for, and may not be used in, all applications. Read complete Disclaimer Notice at <http://www.littelfuse.com/disclaimer-electronics>.