

TF Series

Mid Size Snap-acting Switches



Agency Approvals

Agency	Agency File Number
US	E42363

Specifications

Contact Rating	From low level ¹ to 21 AMPS @ 277 V AC.
Electrical Life	300,000 cycles at 10 AMPS @ 250 V AC, consult Customer Service Center for typical life of higher rated switches.
Insulation Resistance	1,000 M ohm min.
Dielectric Strength	1,500 Vrms min. @ sea level
Operating Temperature	-40°C to +85°C
Operating Force	From 15 to 400 grams at actuator button available
Mounting	Torque screws 2-5 in/lbs

Notes:

¹ Low Level=conditions where no arcing occurs during switching, i.e., 0.4 VA max. @ 20 V AC or DC max. Standard electrical life per UL 1054, rated for 6,000 operations.

Description

The TF series mid size snap-acting switch from C&K features a broad range of operating forces, ratings up to 21A and a wide variety of actuator styles to fit the specific needs of any design. Often used in motor controls, thermostatics and portable tools, designers across the globe turn to the TF series for its performance and resilience.

Features & Benefits

- Broad range of operating forces
- Ratings up to 21 AMPS
- Wide variety of actuator styles
- Quick connect terminations

Applications

- Motor controls
- Thermostatics
- Portable tools

Materials

Switch Housing	Thermoplastic polyester or high temperature thermoplastic (PTS) (UL 94V-0)
Actuator Button	Thermoplastic Polyester
Spring	Copper alloy.
Pivot	
Movable Contacts	Option "01" Gold plating over silver alloy Option "05"
Stationary Contacts	Silver alloy
Terminals	Copper alloy
Actuator Lever	Stainless steel

Notes:

Specifications and materials listed above are for switches with standard options. For information on specific and custom switches, consult Customer Service center.

TF Series

Mid Size Snap-acting Switches



Ordering Number

To order, simply select desired option from each category and place in the appropriate box. For additional options not shown in catalog, consult Customer Service Center.

TF - XX - XX - X - XXX - XX - X

Series

TF: SP, Mom.

Operating Force

CJ: 5.29 oz./150 grams

CC: 0.53 oz./15 grams

CD: 0.88 oz./25 grams

CF: 1.76 oz./50 grams

CG: 2.65 oz./75 grams

EC: 7.94 oz./225 grams

EE: 14.11 oz./400 grams

Electrical Rating

J6: 15 A, 277 V AC; 1/2

HP, 125, 250 V AC; 5 A,

125 V AC "L", 0.5 A, 125

V DC; 0.25 A, 250 V DC

F5: 1 A, 125 V AC; 1 A,

30 V DC

H8: 5 A, 277 V AC; 1/10

HP, 125, 250 V AC

J3: 21 A, 277 V AC; 1 HP,

125 V AC; 2 HP, 250 V AC;

5 A, 125 V AC "L"

K6: 11 A, 277 V AC; 1/3 HP,

125, 250 V AC; 0.5 A, 125 V

DC; 0.25 A, 250 V DC

L3: 20 A, 250 V AC; 1 HP,

125 V AC; 2 HP 250 V AC

Mounting Style

S: Standard

V: Metric

Circuitry:

C: SPDT

W: SPST N.C.

Y: SPST N.O.

Actuator

P00: Pin plunger

A10: 0.81" lever roller, high force

A15: 1.34" lever roller, high force

A20: 1.05" lever roller, low force

A25: 1.56" lever roller, low force

T10: 0.84" lever, high force

T13: 1.34" simulated roller, high force

T14: 1.29" simulated roller, high force

T15: 1.40" lever, high force

T16: 2.34" lever, high force

T18: 2.75" lever, high force

T20: 1.10" lever, low force

T23: 1.56" simulated roller, low force

T24: 1.50" simulated roller, low force

T25: 1.62" lever, low force

T26: 2.57" lever, low force

T28: 2.97" lever, low force

WP0: Wide pin plunger

Terminations

40: 0.187" quick connect

4A: 0.250" quick connect

5A: 0.250" offset quick connect

5B: 0.187" offset quick connect

TF Series

Mid Size Snap-Acting Switches - SP Momentary

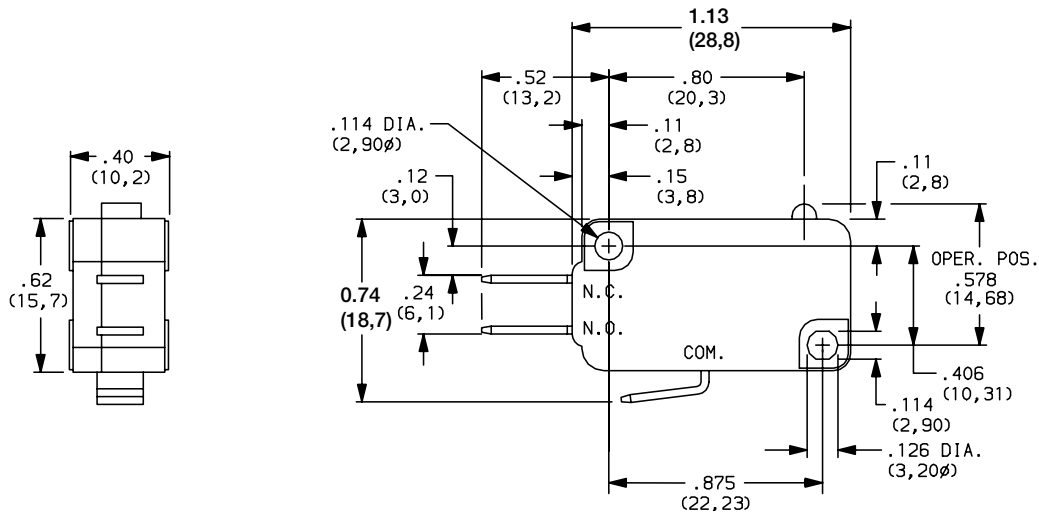

TF Series

Mid Size Snap-acting Switches



Operating Force

Option Code	Basic Switch Operating Force (oz./grams)
CC	.53, 15
CD	.88, 25
CF	1.76, 50
CG	2.65, 75
CJ	5.29, 150
EC	7.94, 225
EE	14.11, 400

Notes:

Minimums may apply, consult Customer Service Center. Operating Force option 'CC' not available with 'T18 & T26' Actuator options. Operating force varies with actuator option, see ACTUATOR option section.

Electrical Rating

Option Code	RoHS Compliant ¹	RoHS Compatible ¹	Contact Material		Electrical Rating us
			Movable Contact	Stationary Contact	
F5	Yes		Gold Alloy		From low level ¹ to 1 AMP @ 125 V AC, 1 AMP @ 30 V DC.
H8			Fine Silver	Fine Silver	5 AMPS @ 277 V AC; 1/10 HP @ 125 & 250 V AC.
J3					21 AMPS @ 277 V AC; 1 HP @ 125 V AC; 2 HP @ 250 V AC; 5 AMPS @ 125 V AC "L".
J6	Yes				15 AMPS @ 277 V AC; 1/2 HP @ 125 & 250 V AC; 5 AMPS @ 125 V AC "L". 0.5 AMP @ 125 V DC; 0.25 AMP @ 250 V DC.
K6					11 AMPS @ 277 V AC; 1/3 HP @ 125 & 250 V AC; 0.5 AMP @ 125 V DC; 0.25 AMP @ 250 V DC.
L3	Yes		Silver Alloy	Fine Silver	20 AMPS @ 250 V AC; 1 HP @ 125 V AC; 2 HP @ 250 V AC

Notes: See Technical Data section of this catalog for RoHS compliant and compatible definition and specifications. All models us Consult Customer Service center for availability and delivery of nonstandard ratings.

¹ Low Level=conditions where no arcing occurs during switching, i.e., 0.4 VA max. @ 20 V AC or DC max.

Operating Force

Electrical Rating	Amps (REF.)	CC (15)	CD (25)	CF (50)	CG (75)	CJ (150)	EC (225)	EE (400)
F5	1	•	•	•	•	•	•	-
H8	5	•	•	•	•	•	•	•
J3	21	X	X	X	X	•	•	•
J6	15	X	X	X	X	•	•	•
K6	11	X	•	•	•	•	•	•
L3	20	X	X	X	X	•	•	•

Notes:

• Available

X Not available.

Available with 4A & 5A terminations only, see page 5. All models us Consult Customer Service center for availability and delivery of nonstandard ratings.

TF Series

Mid Size Snap-acting Switches



Mounting Style

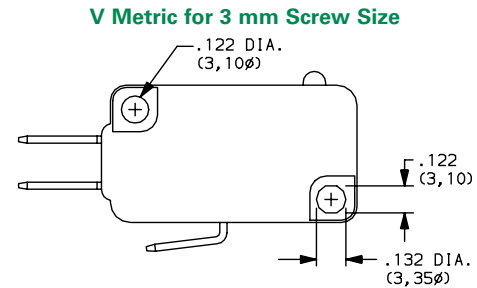
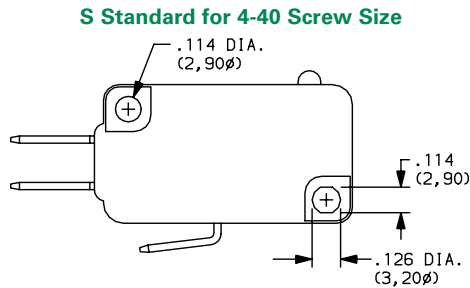

Actuator

Option Code	Fig.	Dim. A	Dim. B	Dim. C	Dim. D
P00	1	.80 (20.3)	-	.578 ± .015 (14.68 ± 0.38)	-
A10	2	.81 (20.6)	.32 (8.1)	.810 ± .020 (20.57 ± 0.51)	.19 dia. (4.8Ø)
A15		1.34 (34.0)		.810 ± .030 (20.57 ± 0.76)	
A20		1.05 (26.7)	.54 (13.7)	.810 ± .050 (20.57) ± 1.27	
A25		1.56 (39.6)		.810 ± .075 (20.57 ± 1.91)	
T10	3	.84 (21.3)	.32 (8.1)	.600 ± .020 (15.24 ± 0.51)	-
T15		1.40 (35.6)		.600 ± .040 (15.24 ± 1.02)	
T16		2.34 (59.4)		.600 ± .065 (15.24 ± 1.65)	
T18		2.75 (69.9)	.54 (13.7)	.600 ± .080 (15.24 ± 2.03)	
T20		1.10 (27.9)		.600 ± .080 (15.24 ± 1.27)	
T25		1.62 (41.1)		.600 ± .070 (15.24 ± 1.78)	
T26		2.57 (65.3)		.600 ± .150 (15.24 ± 3.81)	
T28		2.97 (75.4)		.600 ± .187 (15.24) ± 4.75	
T13		4	1.34 (34.0)	.32 (8.1)	
T14	1.29 (32.8)		.730 ± .030 (18.54 ± 0.76)		
T23	1.56 (39.6)		.54 (13.7)	.810 ± .065 (20.57 ± 1.65)	
T24	1.50 (38.1)			.730 ± .060 (18.54) ± 1.52	
WP0	5	.80 (20.3)	-	.635 ± .015 (16.13 ± .038)	-

TF Series

Mid Size Snap-acting Switches



Figure 1 - Pin Plunger

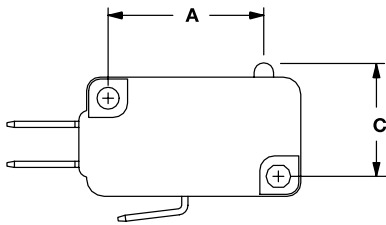

Figure 2 - Lever Roller

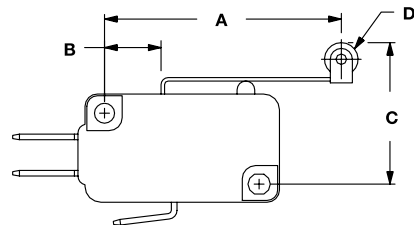

Figure 3 - Lever

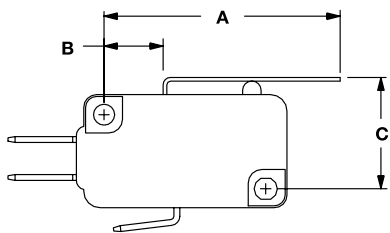

Figure 4 - Simulated Roller

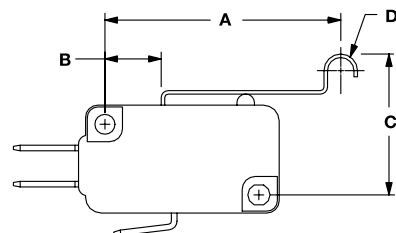
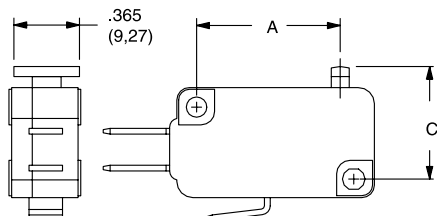

Figure 5 - Wide Pin



Note: Switch characteristics chart on following page.

TF Series

Mid Size Snap-acting Switches



Switch Characteristics

Option Code	Max. Operating Force (oz./grams)							Min. Release Force (oz./grams)							Max. Differential Travel	Max. Pre-Travel	Min. Over Travel
	CC (15)	CD (25)	CF (50)	CG (75)	CJ (150)	EC (225)	EE (400)	CC (15)	CD (25)	CF (50)	CG (75)	CJ (150)	EC (225)	EE (400)			
A10	.63 18	1.06 30	2.29 65	3.17 90	6.35 180	7.94 225	14.11 400	.21 6	.35 10	.35 10	.53 15	.71 20	1.98 56	3.88 110	.015 (0.38)	.060 (1.52)	.030 (0.76)
A15	.28 8	.42 12	1.06 30	1.59 45	3 85	4.59 130	7.94 225	.07 2	.14 4	.14 4	.18 5	.35 10	.71 20	2.82 80	.030 (0.76)	.100 (2.54)	.065 (1.65)
A20	0.53 15	0.71 20	1.41 40	2.12 60	4.23 120	6 170	9.7 275	0.07 2	0.11 3	0.11 3	0.18 5	0.42 12	0.71 20	1.41 40	0.025 (0.64)	0.12 (3.05)	0.055 (1.40)
A25	.18 5	.28 8	.56 16	.85 24	1.69 48	2.65 75	4.41 125	.04 1	.07 2	.07 2	.07 2	.21 6	.35 10	.71 20	.050 (1.27)	.250 (6.35)	.120 (3.05)
P00	.53 15	.88 25	1.76 50	2.65 75	5.29 150	7.94 225	14.11 400	.21 6	.35 10	.35 10	.53 15	1.23 35	1.98 56	3.88 110	.010 (0.25)	.047 (1.19)	.050 (1.27)
T10	.63 18	1.06 30	2.29 65	3.17 90	6.35 180	7.94 225	14.11 400	.21 6	.35 10	.35 10	.53 15	.71 20	1.98 56	3.88 110	.015 (0.38)	.060 (1.52)	.030 (0.76)
T13	.28 8	.42 12	1.06 30	1.59 45	3 85	4.59 130	7.94 225	.07 2	.14 4	.14 4	.18 5	.35 10	.71 20	2.82 80	.030 (0.76)	.100 (2.54)	.065 (1.65)
T14	.28 8	.42 12	1.23 35	1.76 50	3.17 90	4.76 135	7.94 225	.07 2	.14 4	.14 4	.18 5	.35 10	.71 20	2.82 80	.030 (0.76)	.100 (2.54)	.060 (1.52)
T15	.25 7	.42 12	1.06 30	1.41 40	2.82 80	4.41 125	7.94 225	.07 2	.14 4	.14 4	.18 5	.28 8	.63 18	2.82 80	.030 (0.76)	.110 (2.79)	.065 (1.65)
T16	.18 5	.28 8	.53 15	.78 22	1.59 45	2.47 70	4.23 120	.04 1	.07 2	.07 2	.07 2	.28 8	.35 10	.71 20	.045 (1.14)	.250 (6.35)	.125 (3.18)
T18	N/A	.21 6	.42 12	.71 20	1.41 40	2.12 60	3.53 100	N/A	.04 1	.04 1	.07 2	.18 5	.28 8	.56 16	.062 (1.57)	.300 (7.62)	.155 (3.94)
T20	.53 15	.71 20	1.41 40	2.12 60	4.23 120	6 170	9.7 275	.21 6	.35 10	.35 10	.53 15	.71 20	1.98 56	3.88 110	.030 (0.76)	.140 (3.56)	.060 (1.52)
T23	.18 5	.28 8	.56 16	.85 24	1.69 48	2.65 75	4.41 125	.04 1	.07 2	.07 2	.07 2	.21 6	.35 10	.71 20	.050 (1.27)	.250 (6.35)	.120 (3.05)
T24	0.18 5	0.28 8	0.56 16	0.88 25	1.76 50	2.65 75	4.76 135	0.04 1	0.07 2	0.07 2	0.11 3	0.21 6	0.35 10	0.71 20	.005 (1.27)	0.23 (5.84)	0.11 (2.79)
T25	.18 5	.28 8	.53 15	.88 25	1.59 45	2.47 70	4.23 120	.04 1	.07 2	.07 2	.07 2	.21 6	.35 10	.99 28	.055 (1.40)	.250 (6.35)	.125 (3.18)
T26	N/A	.14 4	.28 8	.42 12	.85 24	1.27 36	2.26 64	N/A	.04 1	.04 1	.05 1.5	.12 3.5	.21 6	.39 11	.100 (2.54)	.500 (12.70)	.235 (5.97)
T28	N/A	N/A	N/A	0.42 12	0.71 20	1.06 30	1.94 55	N/A	N/A	N/A	0.04 1	0.11 3	0.18 5	0.32 9	0.12 (3.05)	.0560 (14.22)	0.285 (7.24)
WP0	.53 15	.88 25	1.76 50	2.65 75	5.29 150	7.94 225	14.11 400	.21 6	.35 10	.35 10	.53 15	1.23 35	1.97 56	3.88 110	.010 (0.25)	.047 (1.19)	.030 (0.51)

Note: For basic switch operating forces, see page 3.

High Force, Low Motion Pivot Position

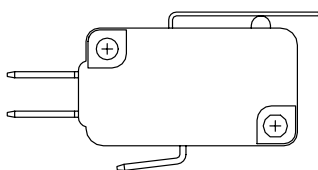

Available with actuators A10, A15, T10, T13, T14, T15, T16 and T18.

Low Force, High Motion Pivot Position

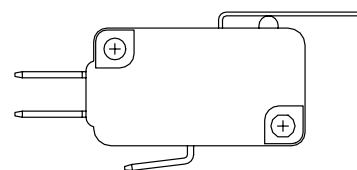

Available with actuators A20, A25, T20, T23, T24, T25, T26, and T28.

Notes: Lever actuator options are available in either of two pivot positions. Levers located in the forward pivot position have lower forces and higher motions. Levers located in the rear pivot position have higher forces and lower motions.

TF Series

Mid Size Snap-acting Switches



Terminations

40 .187" Quick Connect

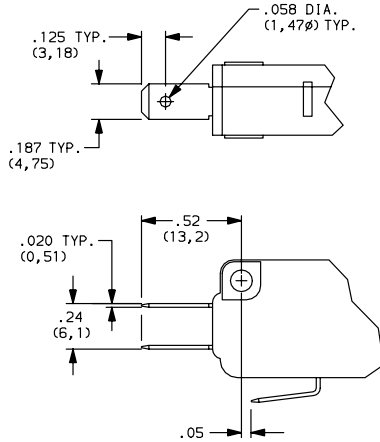

4A .250" Quick Connect

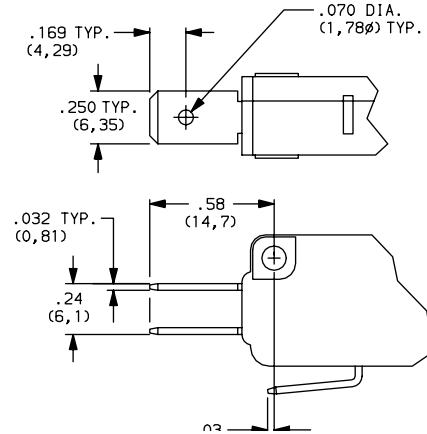

5A Offset .250" Quick Connect

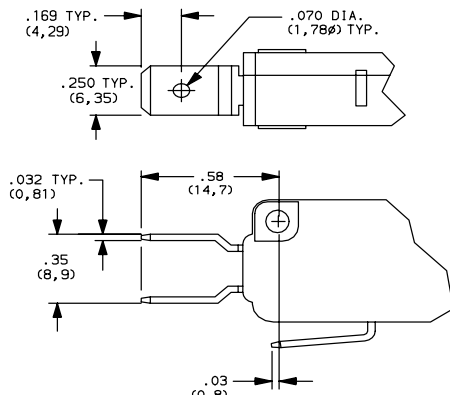

5B Offset .187" Quick Connect

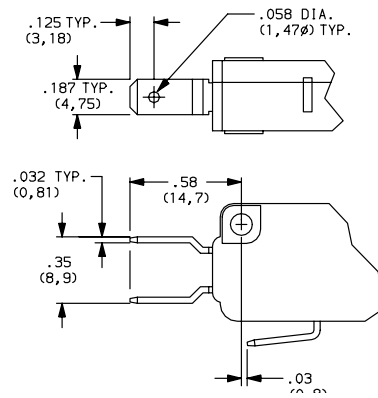

Circuitry

- C** SPDT (Single Pole, Double Throw)
- W** SPST N.C. (Single Pole, Single Throw Normally Closed)
- Y** SPST N.O. (Single Pole, Single Throw Normally Open)

Disclaimer Notice - Information furnished is believed to be accurate and reliable. However, users should independently evaluate the suitability of and test each product selected for their own applications. Littelfuse products are not designed for, and may not be used in, all applications. Read complete Disclaimer Notice at <http://www.littelfuse.com/disclaimer-electronics>.