

TDP Series

Ultra-miniature Surface Mount Half-pitch Side-Actuated DIP Switches

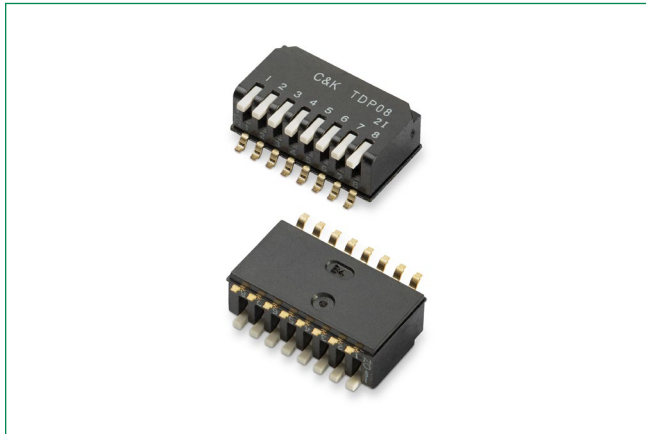

Specifications

Switch Function	SPST - 2, 4, 6, 8, 10 positions
Contact Rating	24 V DC, 25 mA (switching) 50 V DC, 100 mA (steady state)

Mechanical & Electrical Characteristics

Mechanical and Electrical Life	1,000 cycles
Contact Resistance	100 mΩ max.
Insulation Resistance	100M Ω @ 100 V DC min.
Dielectric Strength	300 V AC min.

Environmental Characteristics

Storage Temperature	-40°C to 85°C
Operating Temperature	
Operating Force	4.9N max.

Description

TDP series of ultra-miniature surface mount half-pitch side-actuated DIP switches are used by designers in portable and hand-held electronic devices as well as various instrumentation and control applications. The TDP series are attractive to designers because they are process sealed for surface mount soldering and washable processing and come with side actuation to allow for visual indication of the on/off position in horizontal applications.

Features & Benefits

- World's first ultra-miniature SMT half-pitch side-actuated DIP
- Side actuation allows visual indication of on/off position in horizontal applications
- Process sealed for surface mount soldering and washable processing
- RoHS compliant
- Lead free

Applications

- Hand-held electronic devices
- Portable computer and electronic devices
- Instrumentation and controls

Process

Soldering	Per MIL-STD-202F method 208D, or EIA RS-186E method 9 (1 hour steam aging).
Packaging	Switches supplied in rigid dispensing tubes in full tube quantities only, this may affect order quantity. Tape and reel packaging also available.

Materials

Case & Cover	Glass filled PPS (UL 94 V-0)
Actuator	PA6T (UL 94 V-0)
Contacts	Copper alloy with gold plate over nickel plate
Terminals	Copper alloy, with gold over nickel plate. All terminals are insert molded.
Tape Seal	Polyimide

Note: Specifications and materials listed above are for switches with standard options. For information on specific and custom switches, consult Customer Service Center.

TDP Series

Ultra-miniature Surface Mount Half-pitch Side-Actuated DIP Switches



Ordering Number

Our easy build-a-switch concept allows you to mix and match options to create the switch you need. To order, select desired option from each category and place it in the appropriate box.

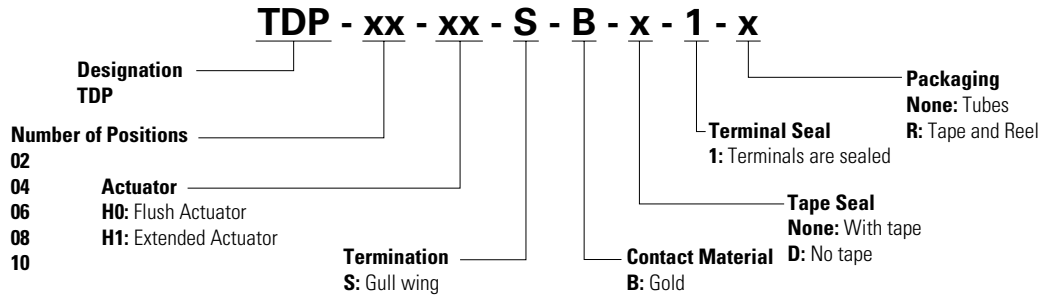

Notes:
Tape seal is not available with H1 Extended Actuators
All switches supplied in "OFF" position

Flush Actuator-No Top Tape, Surface Mount Terminals inches (mm)

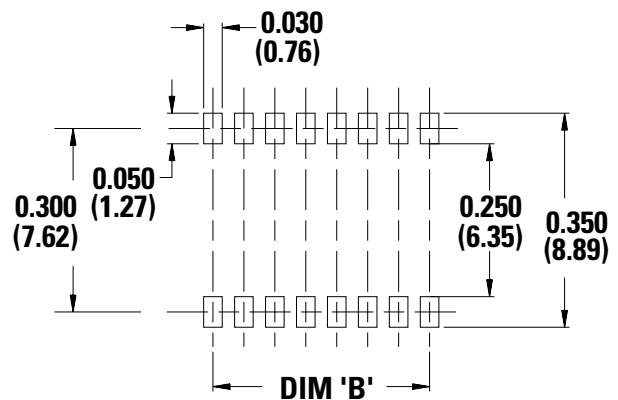
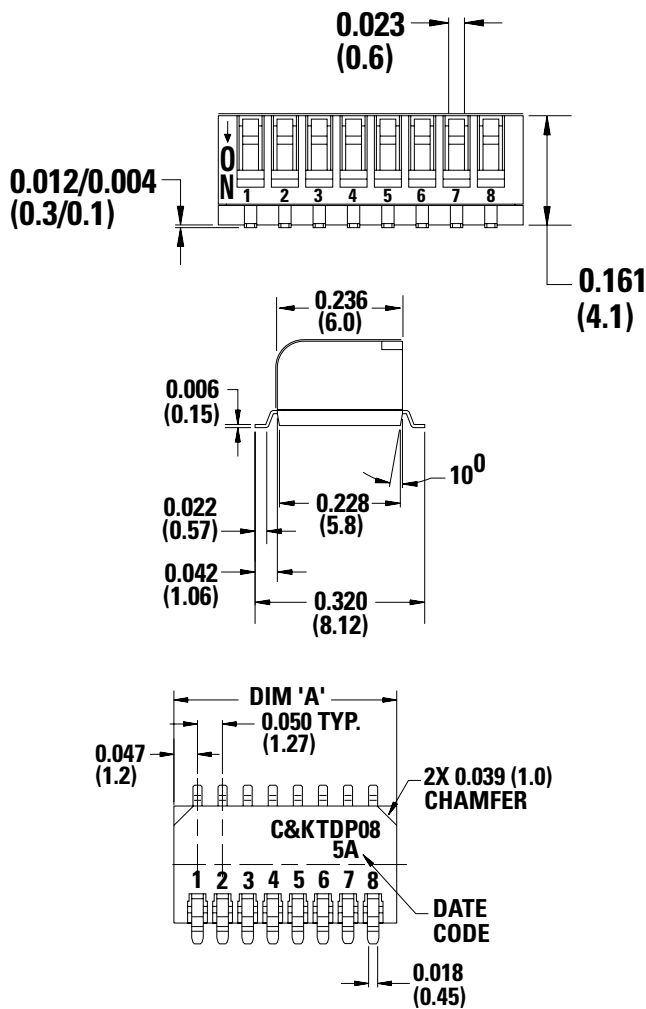

Part #	No. Pos.	DIM 'A'	DIM "B"	Quantity per Tube
TDP02H0SBD1	2	0.144 (3.67)	0.050 (1.27)	125
TDP04H0SBD1	4	0.244 (6.21)	0.150 (3.81)	70
TDP06H0SBD1	6	0.344 (8.74)	0.250 (6.35)	50
TDP08H0SBD1	8	0.444 (11.29)	0.350 (8.89)	40
TDP10H0SBD1	10	0.544 (13.82)	0.450 (11.43)	30

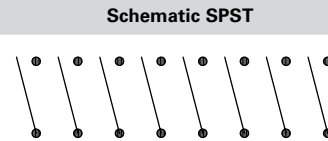

TDP Series

Ultra-miniature Surface Mount Half-pitch Side-Actuated DIP Switches



Flush Actuator-with Top Tape, Surface Mount Terminals inches (mm)

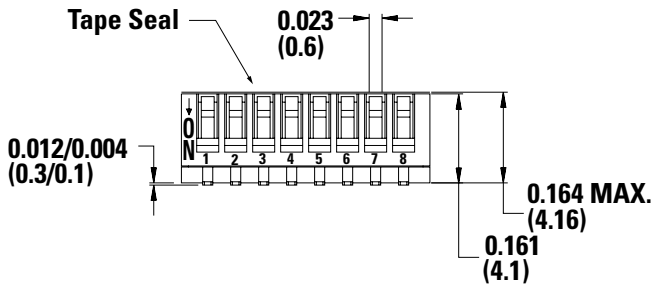
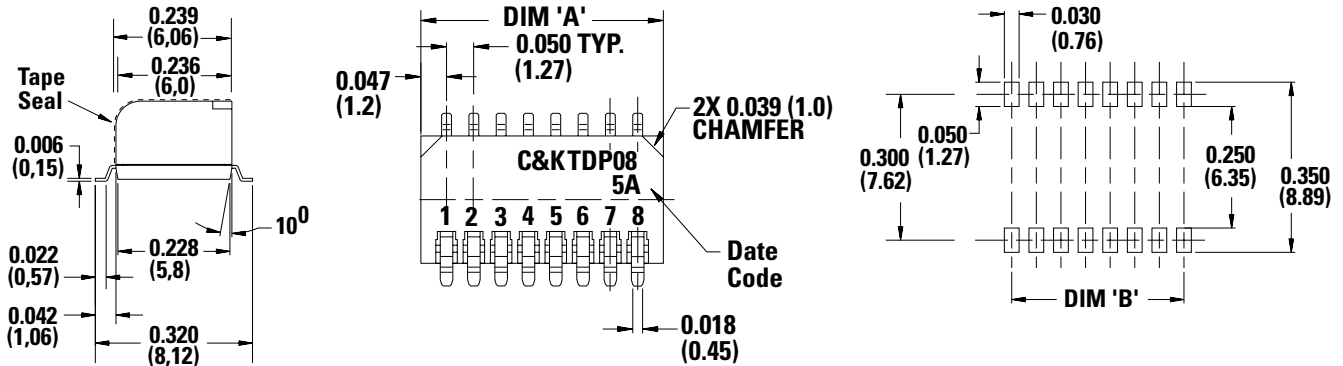

Part #	No. Pos.	DIM 'A'	DIM "B"	Quantity per Tube
TDP02H0SB1	2	0.144 (3.67)	0.050 (1.27)	125
TDP04H0SB1	4	0.244 (6.21)	0.150 (3.81)	70
TDP06H0SB1	6	0.344 (8.74)	0.250 (6.35)	50
TDP08H0SB1	8	0.444 (11.29)	0.350 (8.89)	40
TDP10H0SB1	10	0.544 (13.82)	0.450 (11.43)	30

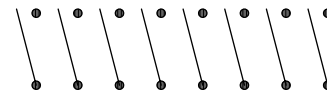

Extended Actuator-No Top Tape, Surface Mount Terminals inches (mm)

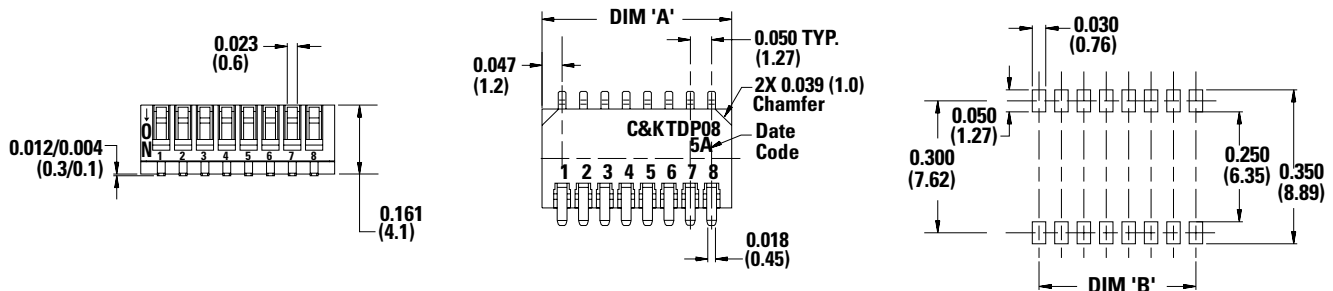

Part #	No. Pos.	DIM 'A'	DIM "B"	Quantity per Tube
TDP02H1SBD1	2	0.144 (3.67)	0.050 (1.27)	125
TDP04H1SBD1	4	0.244 (6.21)	0.150 (3.81)	70
TDP06H1SBD1	6	0.344 (8.74)	0.250 (6.35)	50
TDP08H1SBD1	8	0.444 (11.29)	0.350 (8.89)	40
TDP10H1SBD1	10	0.544 (13.82)	0.450 (11.43)	30

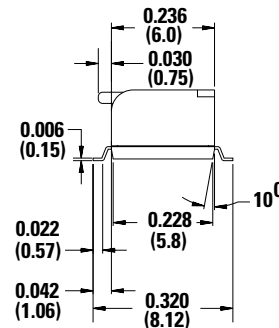
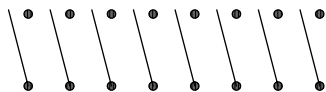

TDP Series

Ultra-miniature Surface Mount Half-pitch Side-Actuated DIP Switches



Tube Packaging inches (mm)

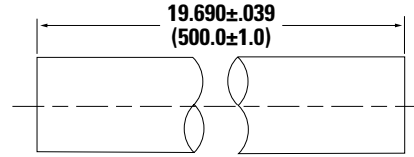
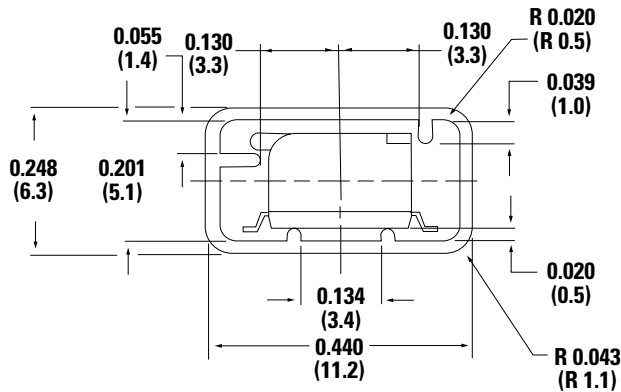

Model #	Quantity per Tube
TDP02	125
TDP04	70
TDP06	50
TDP08	40
TDP10	30

Tape and Reel Packaging inches (mm)

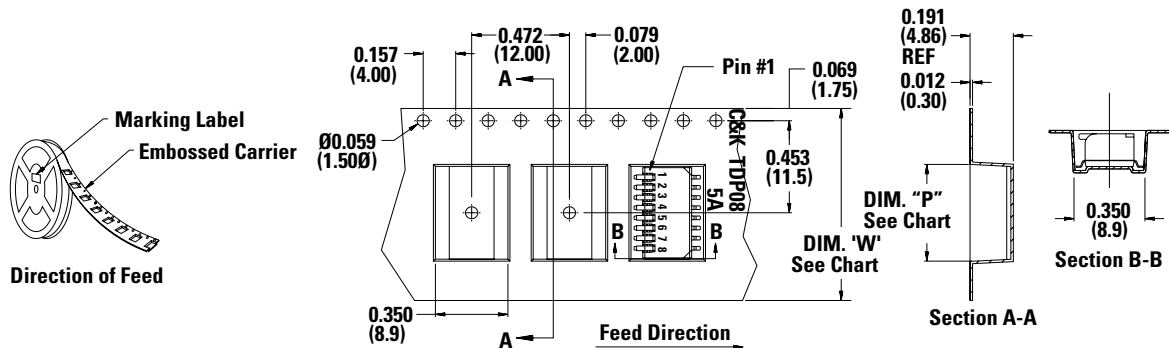

Note: Part Number Shown: TDP08H1SBD1R

DIM Part #	DIM 'W'	DIM "P"	Per Reel
TDP02	0.630 (16.0)	0.175 (4.45)	1,000
TDP04		0.276 (7.0)	
TDP06		0.376 (9.55)	
TDP08	0.945 (24.0)	0.476 (12.1)	1,000
TDP10		0.576 (14.65)	

Disclaimer Notice - Information furnished is believed to be accurate and reliable. However, users should independently evaluate the suitability of and test each product selected for their own applications. Littelfuse products are not designed for, and may not be used in, all applications. Read complete Disclaimer Notice at <http://www.littelfuse.com/disclaimer-electronics>.